

NO	NOM DE LA PIÈCE
301	ENTRÉE PRINC.
302	ATTENTE PRINC.
303	W.C.
304	DÉTENTE
305	CIRCULATION
306	ACCUEIL PRINC.
307	PHOTO A
308	PHOTO B
309	PHOTO C
310	PHOTO D
311	ACCUEIL PHOTO
312	ATTENTE PHOTO
313	MECANIQUE
314	ENTRÉE PHOTO
315	DRE BRASSARD
316	CORRIDOR SERVICE
317	EXAM 1
318	EXAM 2
319	EXAM 3
320	EXAM 4
321	EXAM 5
322	EXAM 6
323	CYNTHIA
324	BUREAU MÉDECIN
325	W.C.
326	ENTREPOT
327	CLINIQUE / LABORATOIRE
328	DENTISTE
329	ESTHÉTICIENNE

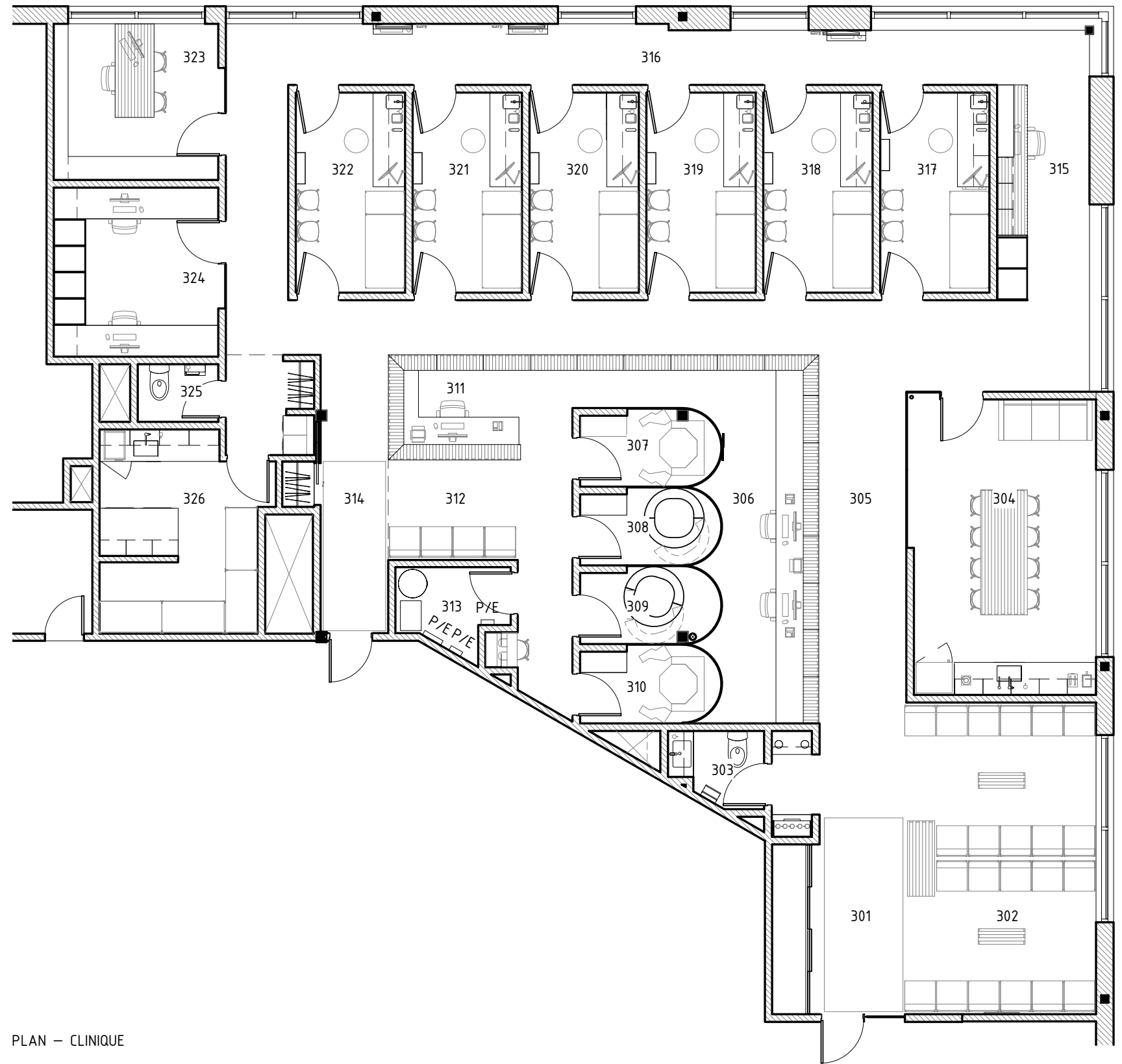

PLAN - CLINIQUE

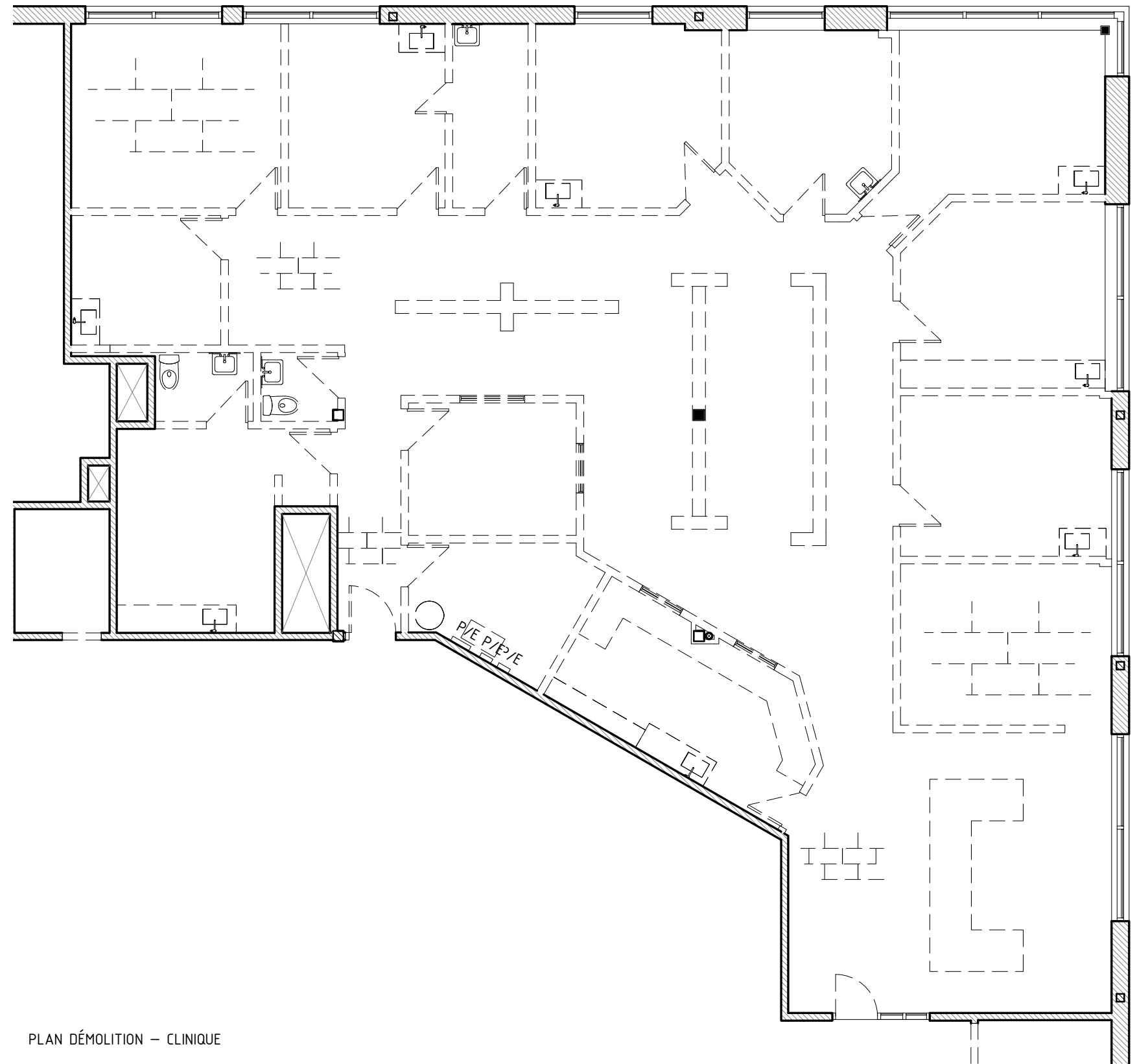

PLAN DÉMOLITION – CLINIQUE

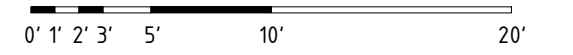

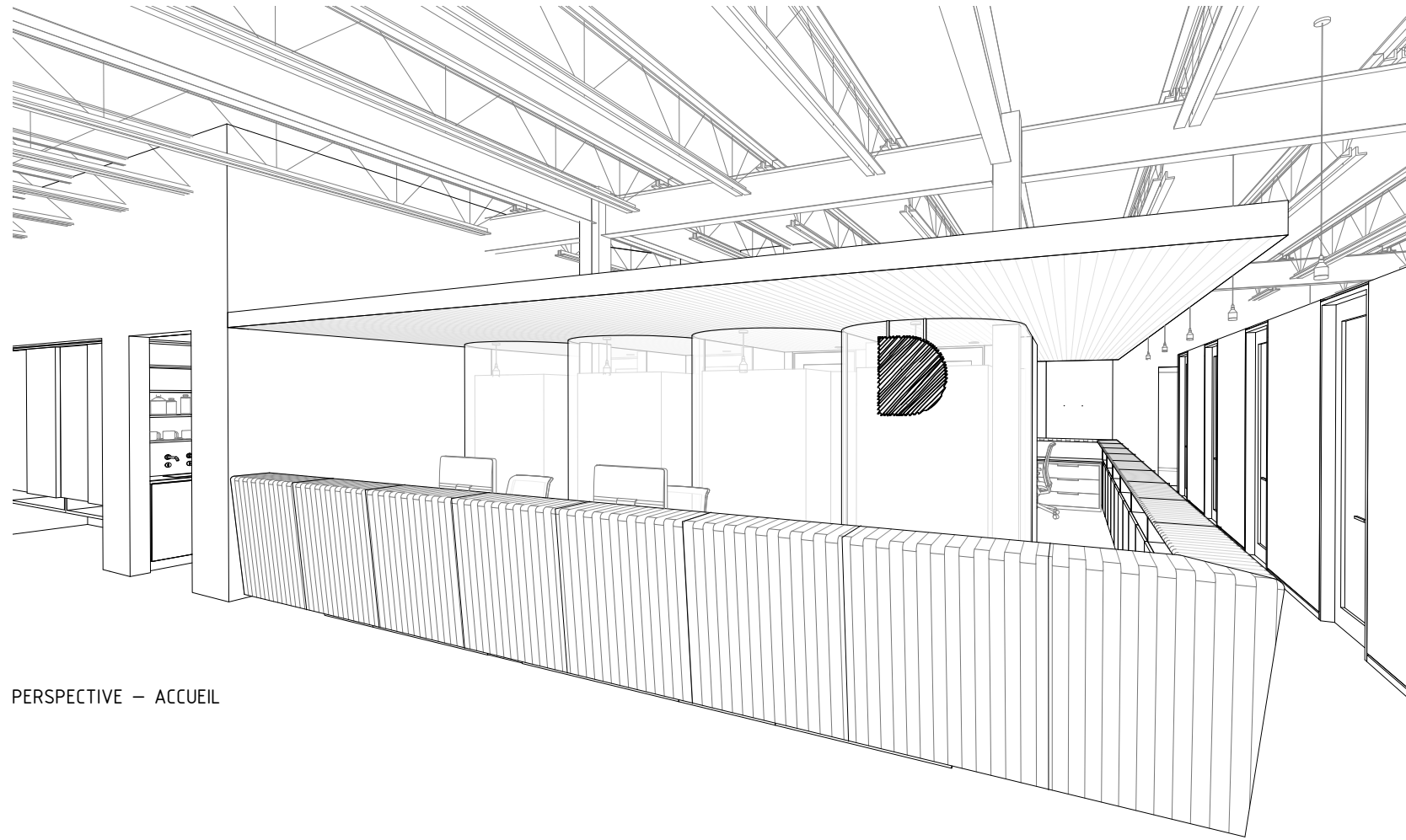

PERSPECTIVE – ACCUEIL

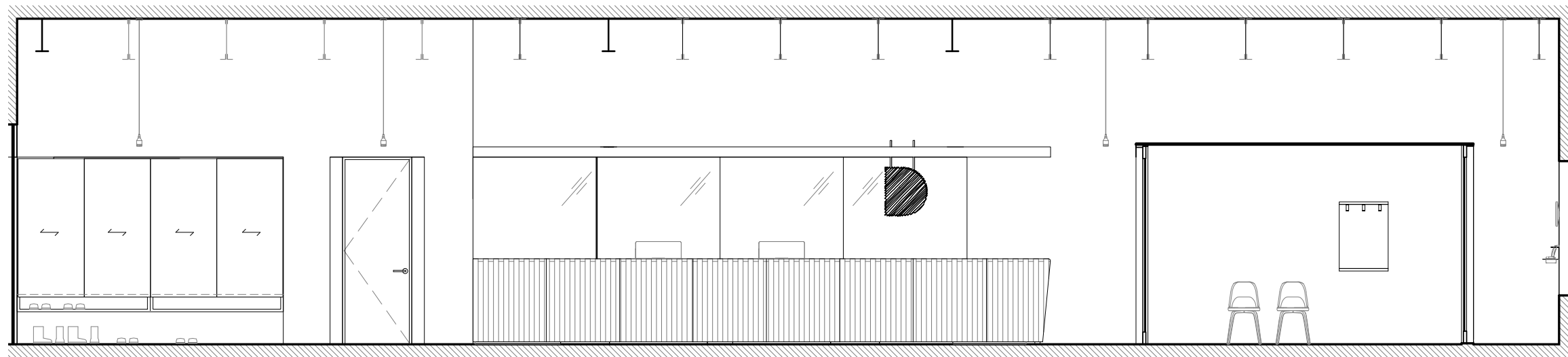

ÉLÉVATION INTÉRIEURE – ACCUEIL

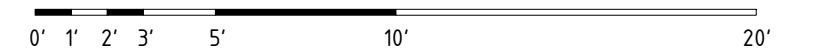

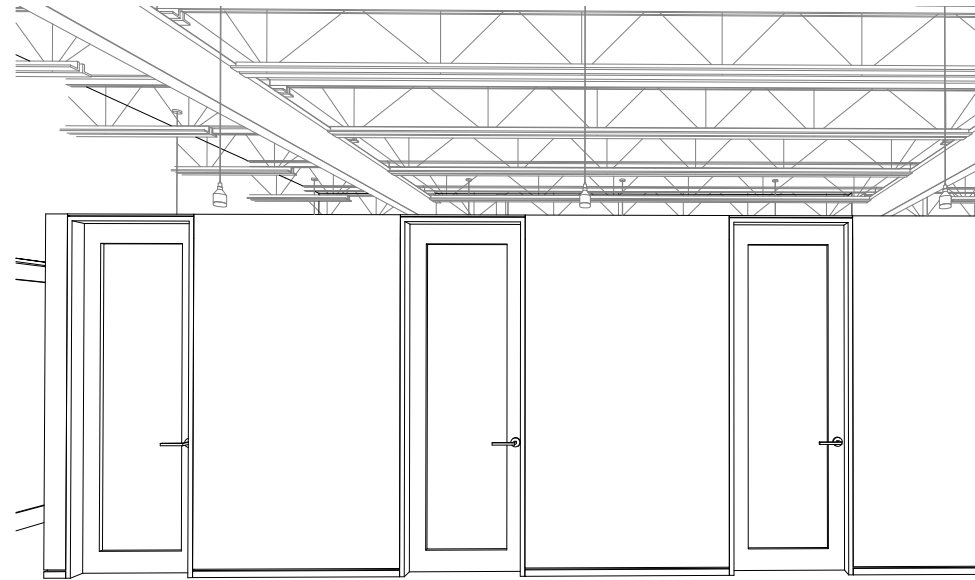

PERSPECTIVE – PORTES SALLE EXAM

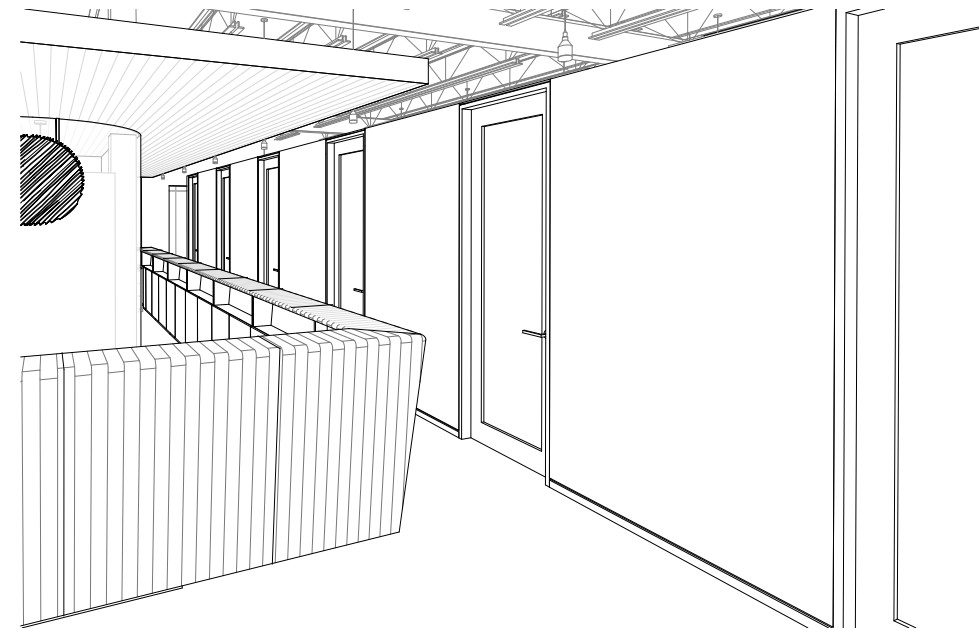

PERSPECTIVES – PORTES SALLES D'EXAMEN

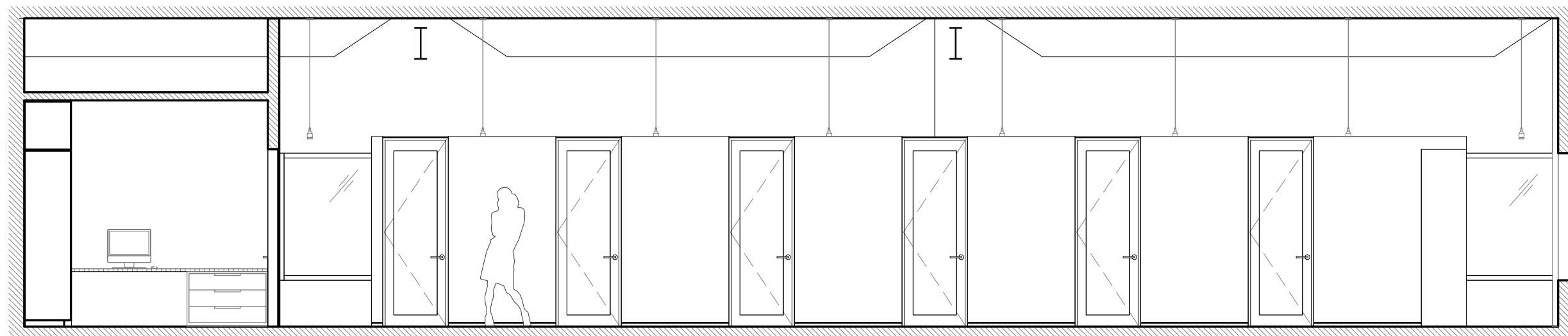

ÉLÉVATION INTÉRIEURE – SALLES D'EXAMEN

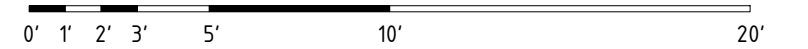



PERSPECTIVE – SALLE D'EXAMEN

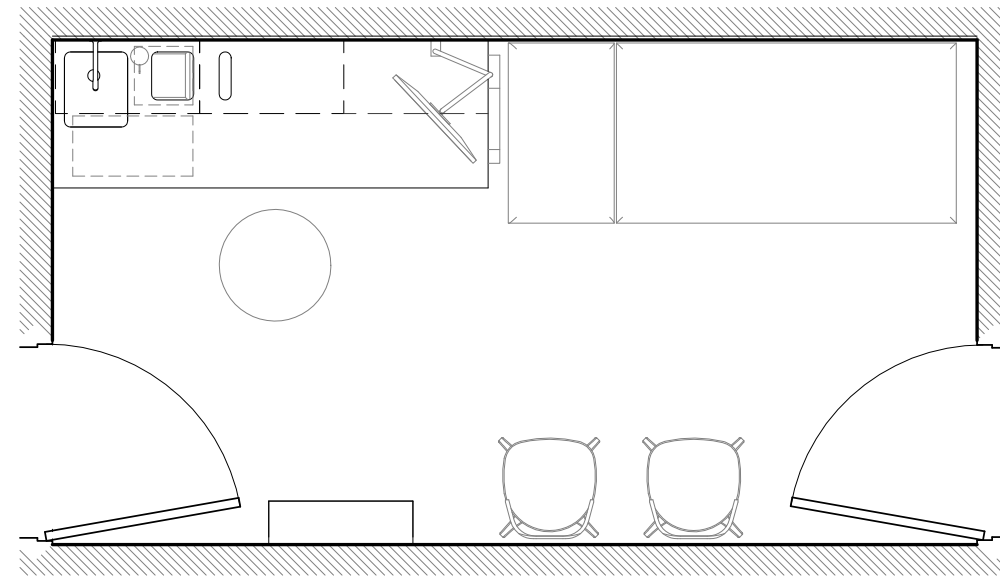

PLAN – AGRANDI SALLE D'EXAMEN

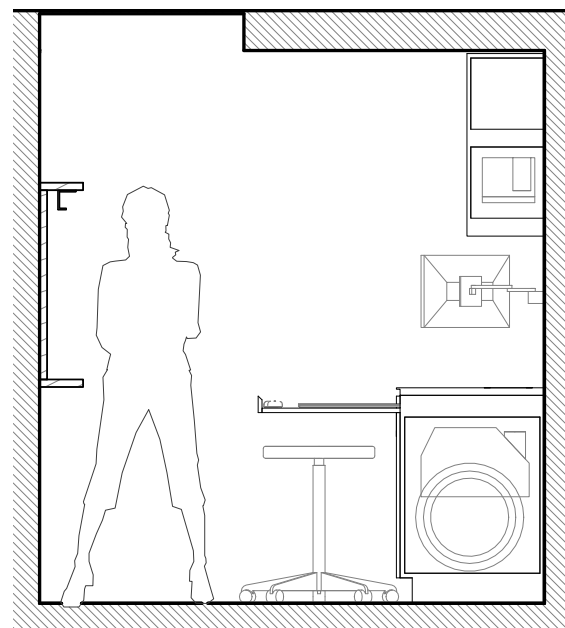

COUPE – SALLE D'EXAMEN

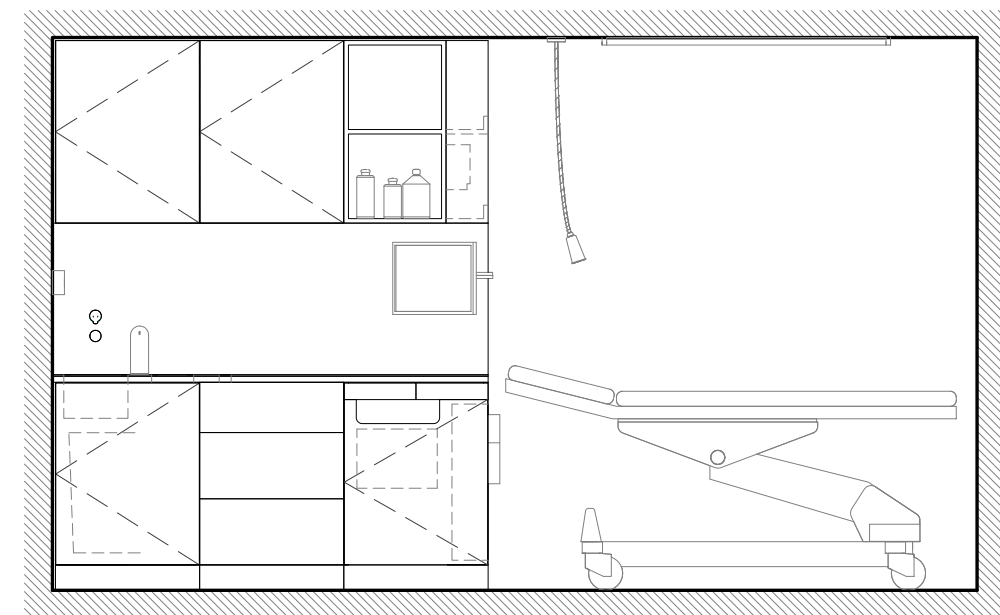

ÉLÉVATION – SALLE D'EXAMEN

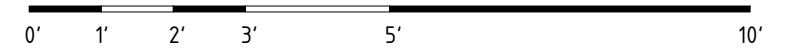

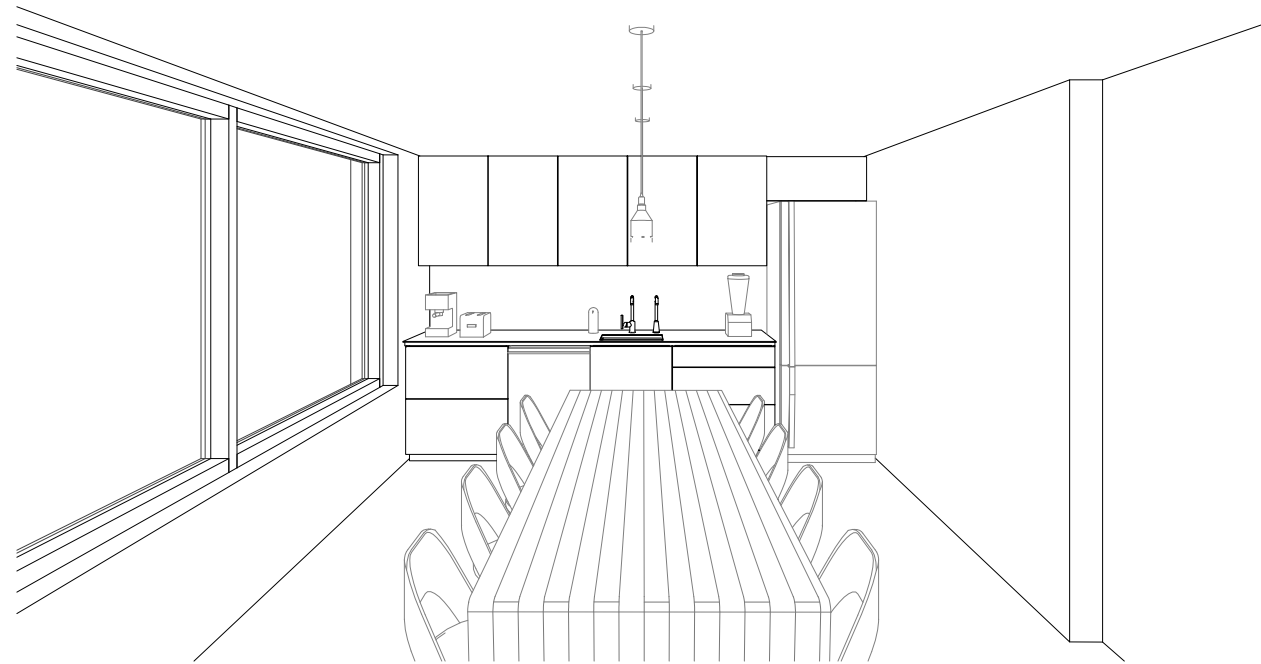

PERSPECTIVE – CUISINE

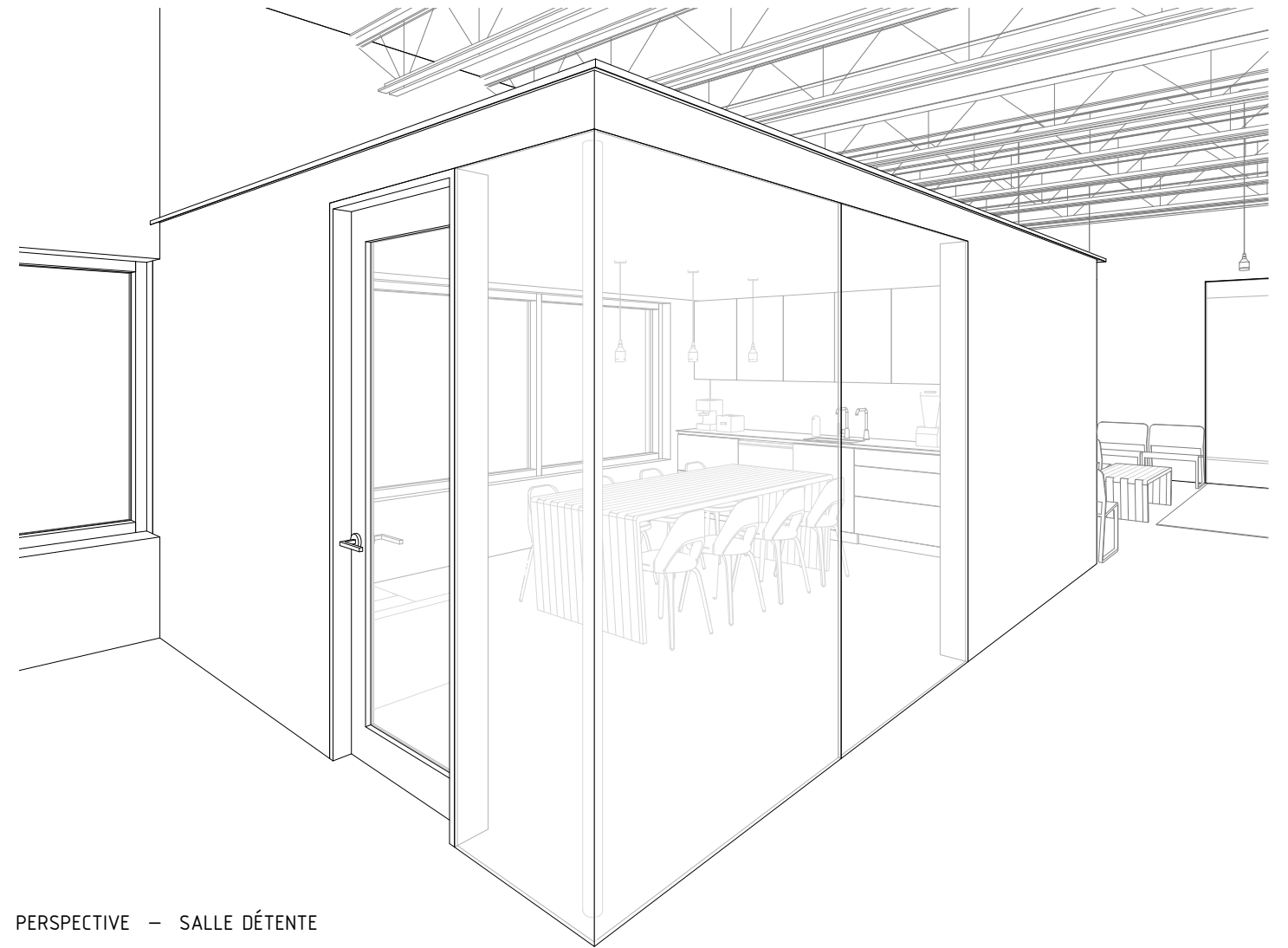

PERSPECTIVE – SALLE DÉTENTE

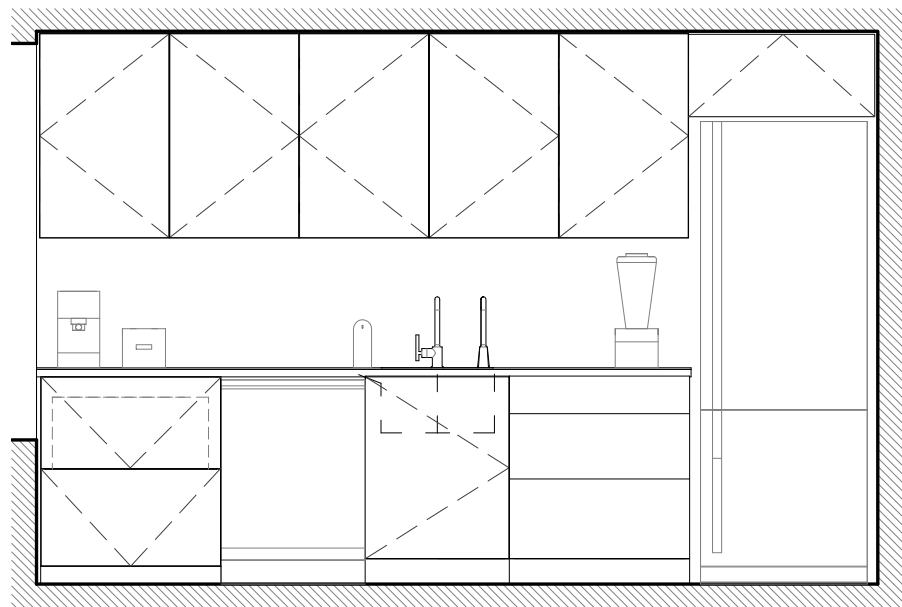

ÉLÉVATION – CUISINE

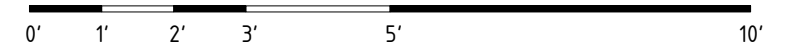



PERSPECTIVE – BUREAU DRE BRASSARD/CORRIDOR SERVICES

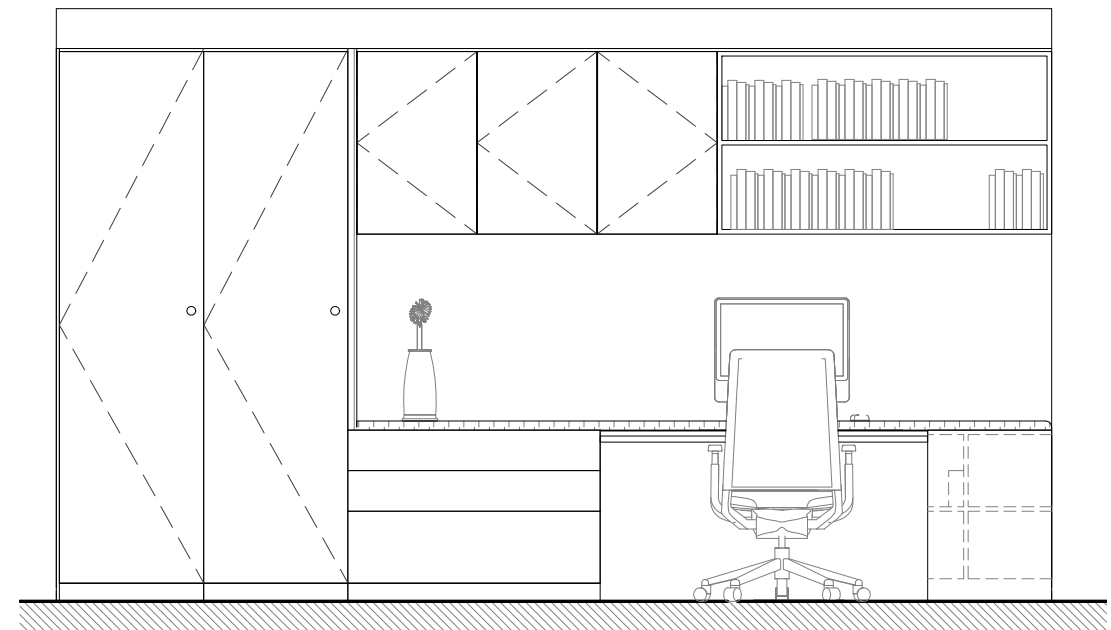

ÉLÉVATION – BUREAU DRE BRASSARD

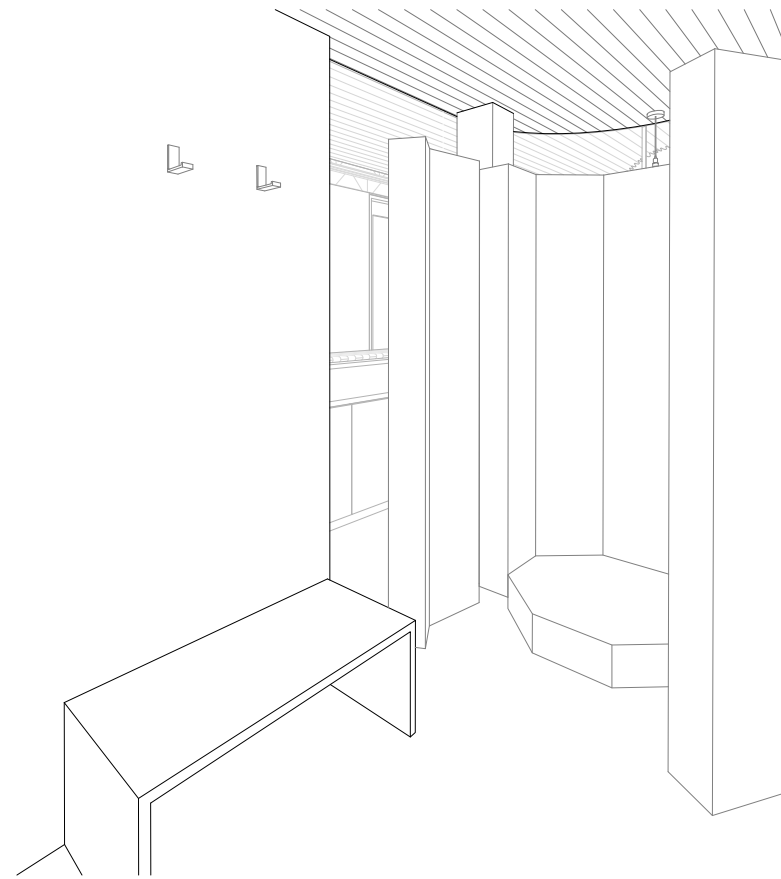

PERSPECTIVE – SALLE PHOTOTHÉRAPIE

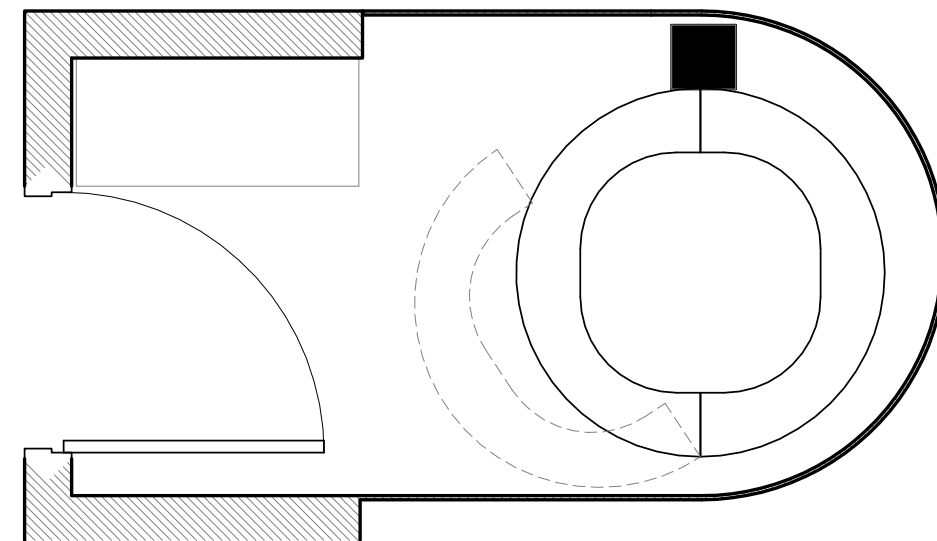

PLAN – AGRANDI SALLE PHOTOTHÉRAPIE

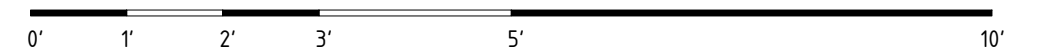



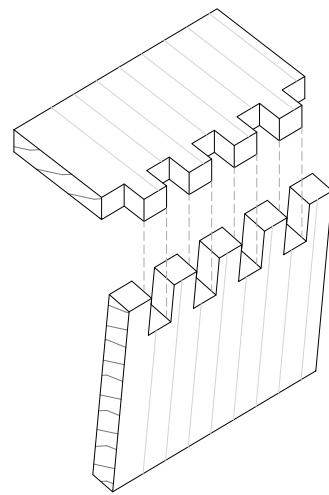

AXONOMÉTRIE – JONCTION PANNEAUX MASSIFS

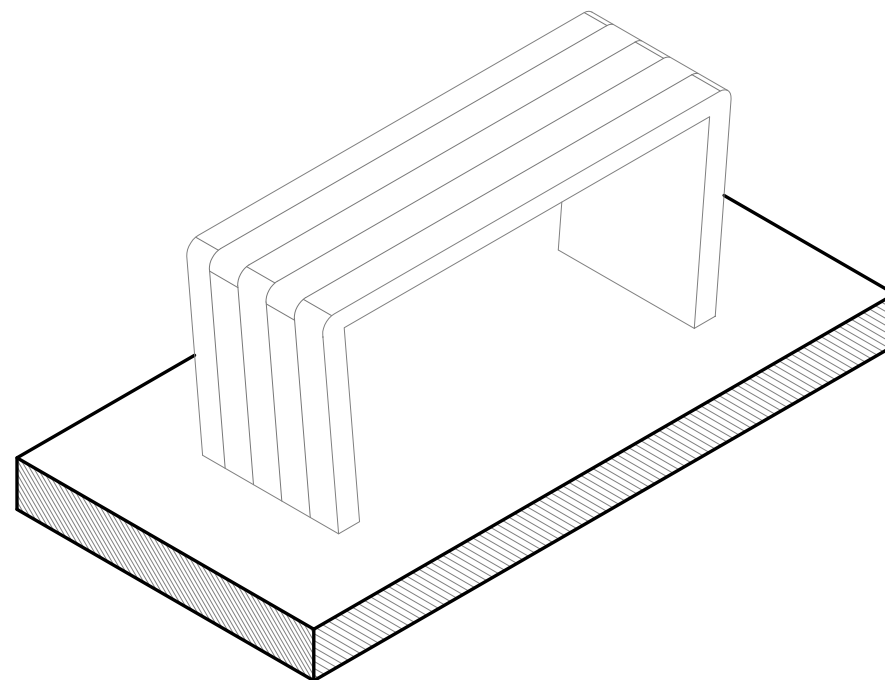

AXONOMÉTRIE – TABLE CAFÉ

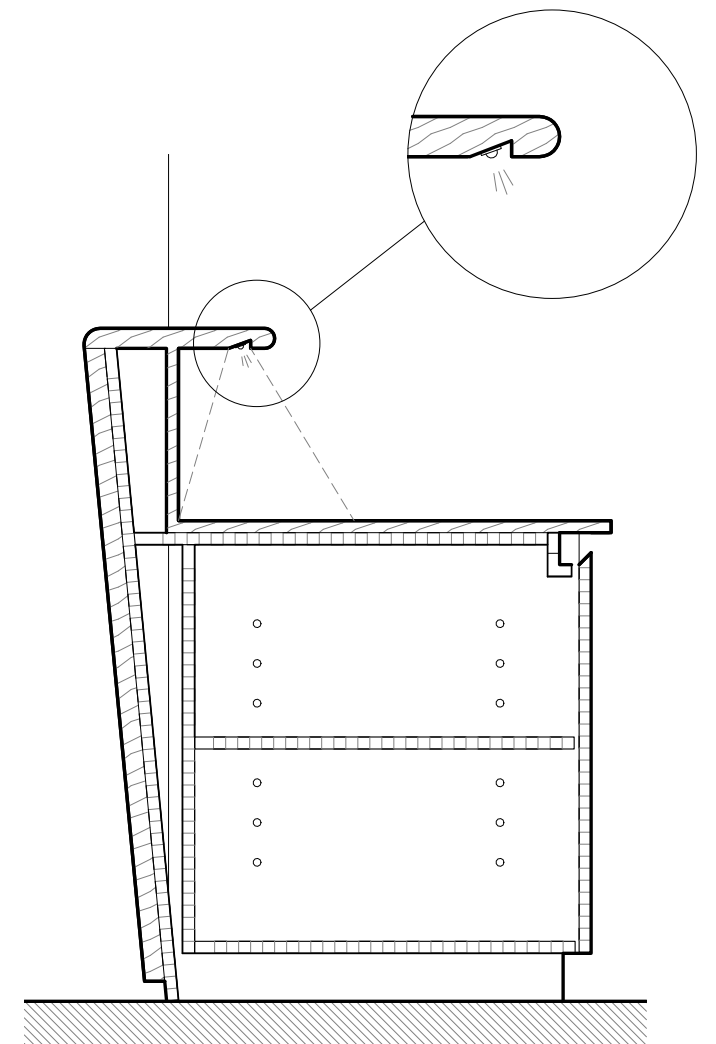

COUPE – ARMOIRE BASSE BUREAU ACCUEIL

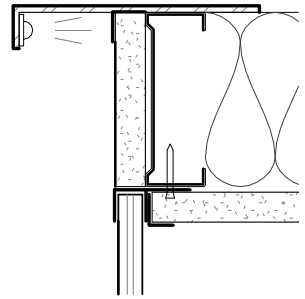

COUPE – VERRE / GYPSE

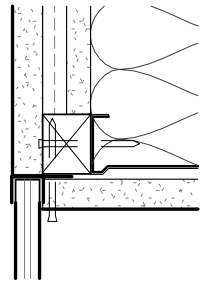

COUPE – VERRE / COIN GYPSE

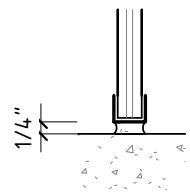

COUPE – VERRE / BÉTON

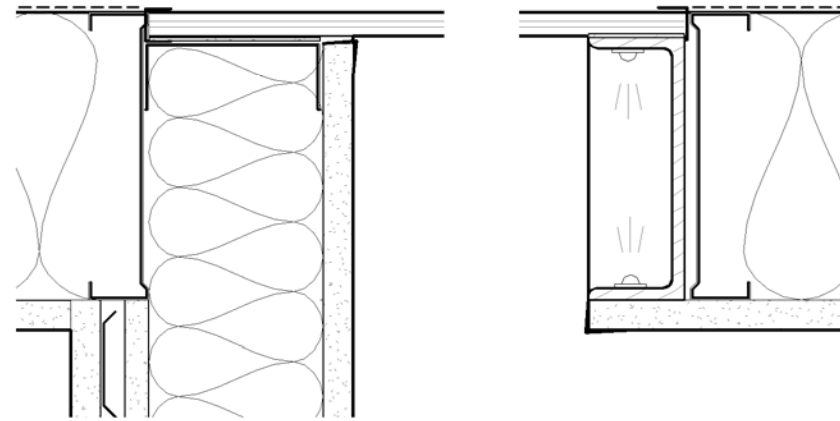

COUPE – PLAFOND EXAM

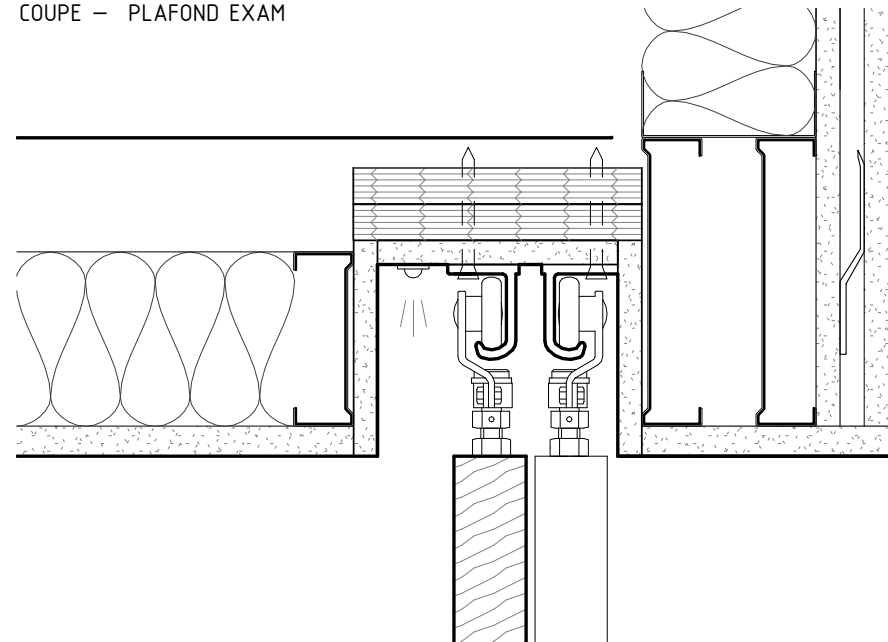

COUPE – COULISSE GARDE-ROBE

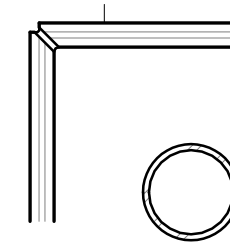

PLAN – COIN VERRE



PLAN – VERRE / VERRE

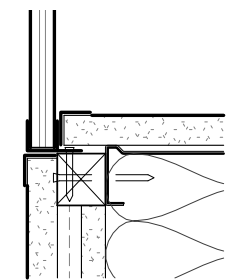

PLAN – VERRE / GYPSE



PLAN – VERRE COURBE

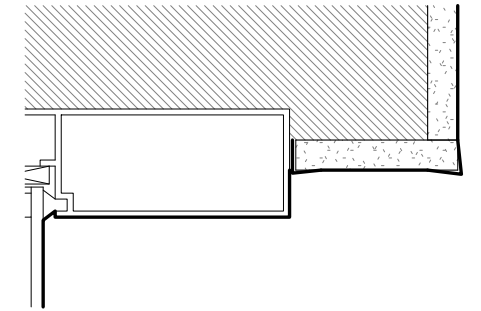

COUPE – LINTEAU FENÊTRE

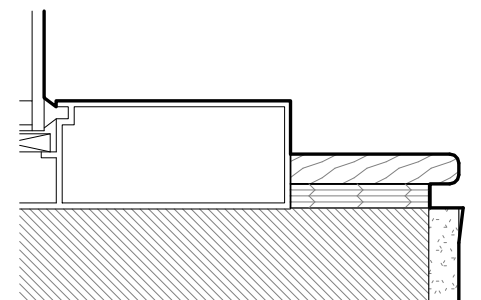

COUPE – ALLÈGE FENÊTRE